



"WE MAKE THE KITCHEN BETTER!"

ATOSA USA, INC.

Toll Free: 855-855-0399 Email: info@atosausa.com

www.atosa.com | www.atosausa.com

California, Colorado, Florida, Georgia, Illinois,
New Jersey, Ohio, Texas, Washington

Black Exterior Glass Door Freezer Merchandisers

Standard Features

- Black steel exterior with stainless steel interior
- Maintains temperatures between -8°F – 0°F
- Lighted header panel
- LED interior lighting standard
- Electronic temperature controller
- Four (4) shelves standard per section
- Double pane glass door(s)
- Self-closing door(s) with automatic stay open feature
- Recessed door handle
- Door lock(s) standard
- Magnetic door gasket
- Self-contained bottom mount refrigeration system with environmentally friendly R290 refrigerant
- Pre-installed casters & shelves

Optional Accessories

- Extra shelves – includes 4 shelf clips per shelf
- MCF8720GR(L) – shelf part#: W0402394
- MCF8721ES – shelf part#: W0402395
- MCF8728GR – shelf part#: W0402395, W0402396 (Middle)
- MCF8732GR – shelf part#: W0402197

For the best results of food preservation we recommend setting your freezer between -8°F to 0°F

1. Don't forget to leave the unit some room to breathe!
2. Please clean the condenser frequently to give the unit more fresh air.



2 YEAR PARTS AND LABOR WARRANTY
5 YEAR COMPRESSOR PART WARRANTY

MODELS:

MCF8720GR / MCF8720GRL / MCF8732GR
MCF8721ES / MCF8728GR



MCF8720GR

MCF8720GRL

MCF8721ES



MCF8732GR

MCF8728GR

Model #	Lighted header panel overall dimensions	Lighted header panel visual dimensions
MCF8720GR(L)	26 ⁹ / ₁₆ ×9 ¹ / ₁₆ ×1/8	25 ¹¹ / ₁₆ ×8
MCF8732GR	39 ¹ / ₁₆ ×9 ¹ / ₁₆ ×1/8	38 ³ / ₁₆ ×8
MCF8721ES	54×9 ¹ / ₁₆ ×1/8	53 ¹ / ₈ ×8
MCF8728GR	81 ⁷ / ₁₆ ×9 ¹ / ₁₆ ×1/8	80 ⁹ / ₁₆ ×8



MCF8721ES



REV. 12/24



"WE MAKE THE KITCHEN BETTER!"

ATOSA USA, INC.

Toll Free: 855-855-0399 Email: info@atosausa.com

www.atosa.com | www.atosausa.com

California, Colorado, Florida, Georgia, Illinois,

New Jersey, Ohio, Texas, Washington

SPECIFICATIONS

Models	Door	Capacity (Cu.Ft.)	Shelves	Casters (inch)	Rated Current (A)	Voltage (V/Hz/Ph)	HP	Refrigerant	Plug	Exterior Dimensions (inch)	Net Weight (lb)	Gross Weight (lb)
MCF8720GR	1	19.4	4	2	2.1	115/60/1	1/2	R290	NEMA 5-15P	27×31 ^{1/2} ×81 ^{1/5}	309	340
MCF8720GRL	1	19.4	4	2	2.1	115/60/1	1/2	R290	NEMA 5-15P	27×31 ^{1/2} ×81 ^{1/5}	309	340
MCF8732GR	2	28.5	8	2	8.6	115/60/1	3/4	R290	NEMA 5-15P	39 ^{1/2} ×31 ^{1/2} ×81 ^{1/5}	392	443
MCF8721ES	2	43.8	8	2	8.6	115/60/1	3/4	R290	NEMA 5-15P	54 ^{2/5} ×31 ^{1/2} ×81 ^{1/5}	498	558
MCF8728GR	3	68	12	2	6.2	115/208-230/60/1	1	R290	NEMA L14-20P	81 ^{9/10} ×31 ^{1/2} ×81 ^{1/5}	673	781

PLAN VIEW

MCF8720GR

MCF8720GRL

MCF8732GR

MCF8721ES

MCF8728GR

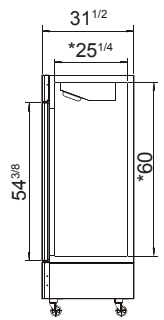
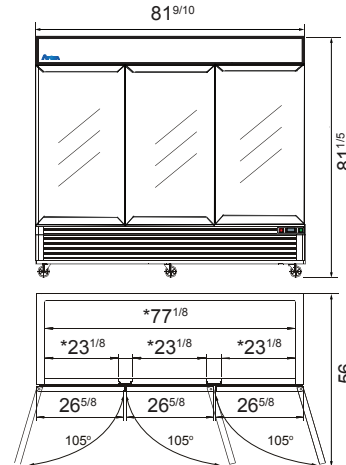
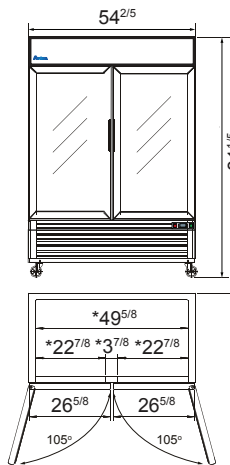
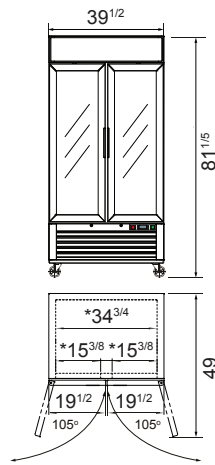
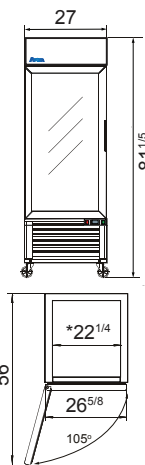
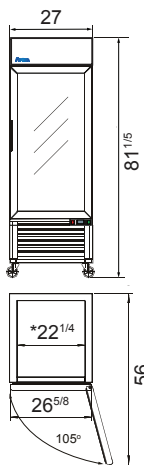

*Interior Dimensions

SELF-CLOSING AND STAY OPEN DOOR FEATURE



MCF8728GR

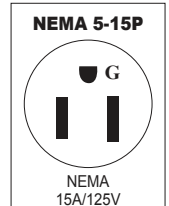

MCF8720GR
MCF8732GR
MCF8721ES

Casters



Temperature control

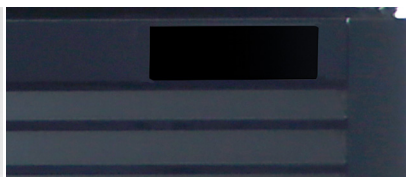

Door lock



LED lights

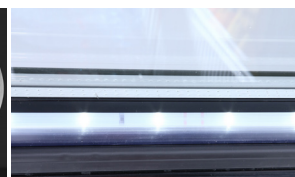

Epoxy shelves

